

Data Sheet



Article number: 2301080111

Description: E+G Handwheel
VRU.160+I

Measures

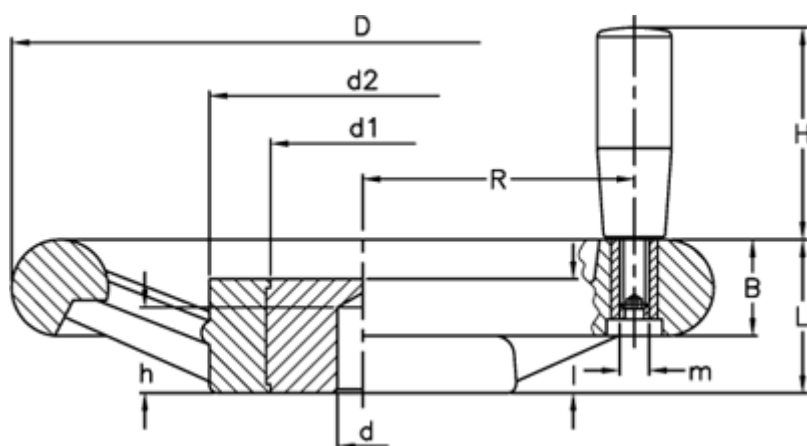

B	= 22	I	= 26
C (N m)	= 350	L	= 35
D	= 160	L (J)	= 13
d1	= 42	m	= M8
d2	= 70	R	= 60
d H9	= 10		
H	= 65		
h	= 17		